

DAEWOO

Colour Television

Instruction Manual

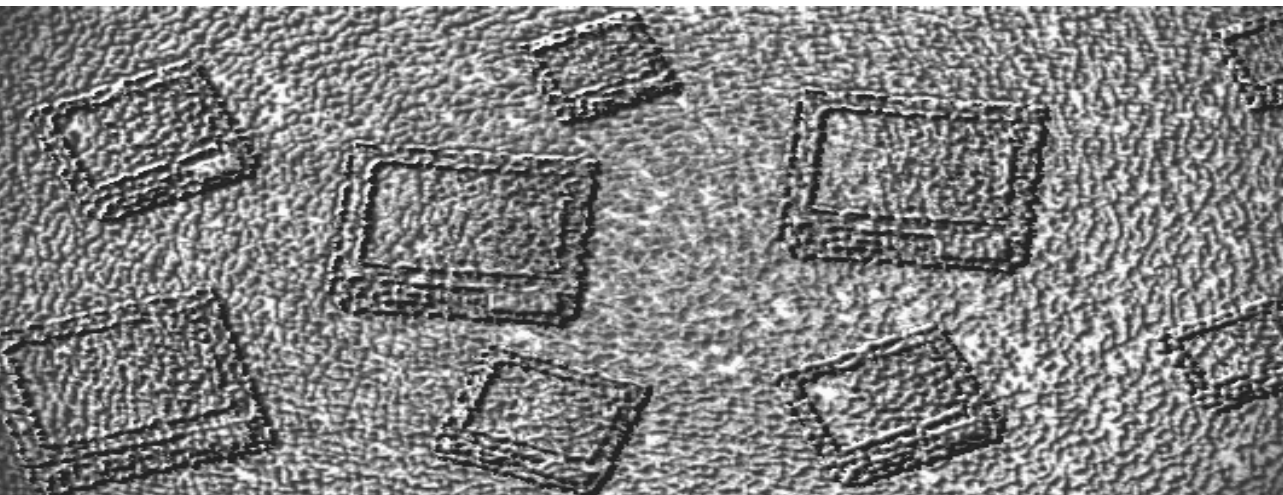

MODEL NO. : DWP-28W2D, DWP-28W2KD, DWP-28W2GBD
DWP-28W2FD, DWP-28W2SD
DWP-28W2, DWP-28W2K, DWP-28W2GB
DWP-28W2F, DWP-28W2S



Manufactured under license from Dolby Laboratories.
"Dolby" and the double-D symbol are trademarks of Dolby Laboratories.

ADDITIONAL INFORMATION FOR THE SET SOLD IN GREAT BRITAIN

The appliance is supplied with a moulded three pin mains plug fitted with 5Amp fuse. Should the fuse require replacement, it must be replaced with a fuse rated at 5 amp and approved by ASTA or BSI to BS1362.

The plug contains a removable fuse cover that must be refitted when the fuse is replaced. In the event of the fuse cover being lost or damaged, the plug must not be used until a replacement cover has been obtained. Replacement fuse covers can be purchased from your nearest electrical dealer and must be the same colour as the original.

If the moulded mains plug is unsuitable for the socket outlet in your home or is removed for any other reasons, then the fuse should be removed and the cut off plug disposed of safely to prevent the hazard of electric shock.

There is a danger of electric shock if the cut off plug is inserted into any socket outlet. If a replacement plug is to be fitted, please observe the wiring code shown below. The wires in the mains lead are coloured in the accordance with the following code:

Blue-neutral

Brown-live

As the colours of the wires in the main lead of this appliance may not correspond with the coloured markings identifying the terminals in your plug, proceed as follows:

The wire which is coloured blue must be connected to the terminal which is marked with the letter N or coloured black. The wire which is coloured brown must be connected to the terminal which is marked with the letter L or coloured red.

Do not make any connections to the terminal in the plug which is marked by the letter E or by the safety earth symbol or coloured green or green and yellow.

CONTENT



Important safeguards.....3



Before Powering up.....4



Identity of features on local and remote control.....5



Connecting external equipment.....7



Daily use.....9



Menu.....11



Teletext.....19

IMPORTANT SAFEGUARDS



WATER AND MOISTURE

Never install the set in the following places: In a wet basement, bathroom. Do not place any container with liquid on the set.



HEAT

Never place the set near heat sources.



VENTILATION

Do not cover the air vents in the cabinet and never place the set in a confined space such as bookcase or built-in furniture unless proper ventilation is provided. Leave a minimum 10 cm gap all around the unit.



OBJECT ENTRY

Do not insert foreign objects, such as needles and coins, in the air vents.



LIGHTNING STRIKING

You should disconnect the set from the mains and the aerial system during thunderstorms.

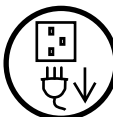

CLEANING

Unplug the set from the mains during cleaning.



AFTER MOVING THE SET

If the set is moved in a different direction, the MAIN POWER button must be switched off for at least 15 minutes in order to take out colour patches on the screen.

BEFORE POWERING UP



INSERTING BATTERIES INTO THE REMOTE CONTROL UNIT

Insert the batteries (two 1,5V, type AAA)

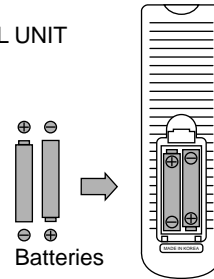

MAINS CONNECTION

Plug the mains cable into the power socket with 240v / 50Hz AC.

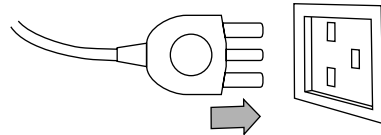

AERIAL CONNECTION

When using an outdoor aerial, it is usually connected to the set by means of 75 ohm lead, terminated with a coaxial plug.

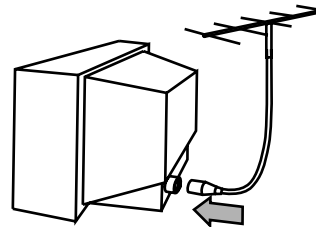

SWITCHING ON AND OFF

Switching on

Switch the set on with the MAIN POWER button, (ON/OFF), and then PR UP or DOWN button on the front of the set. Or POWER button or the UP/DOWN button or one of the NUMBER buttons on the remote control unit.

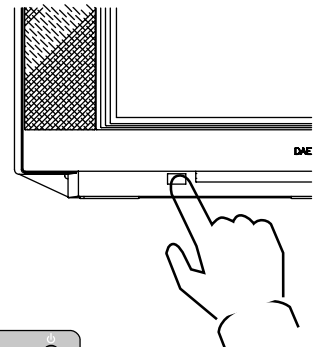

Switching off

Press POWER button, (\cup), on the remote control unit to return the set to its stand by mode. If you don't use the set for an extended period of time, turn it off with the MAIN POWER button on the set.



DENSITY OF FEATURES ON LOCAL AND REMOTE CONTROL

LOCAL CONTROL

Front

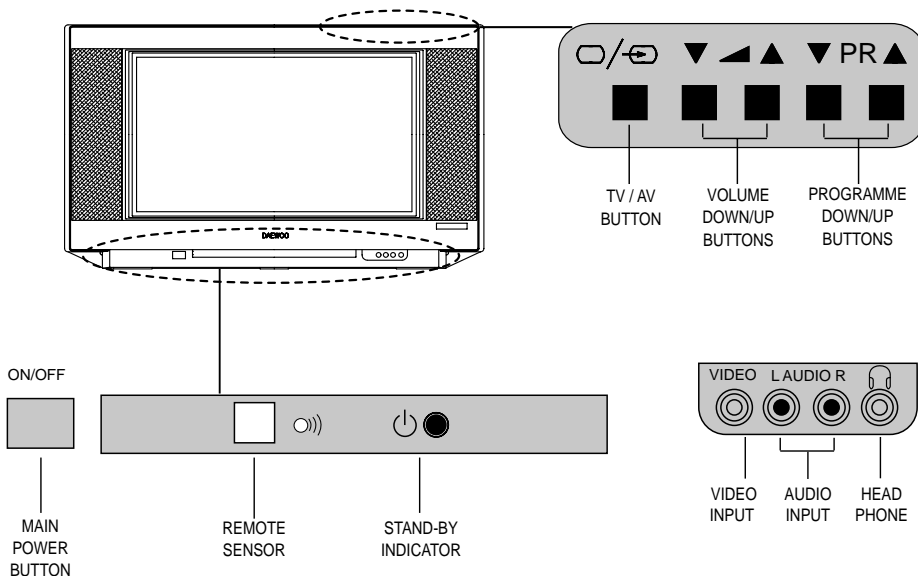

Back

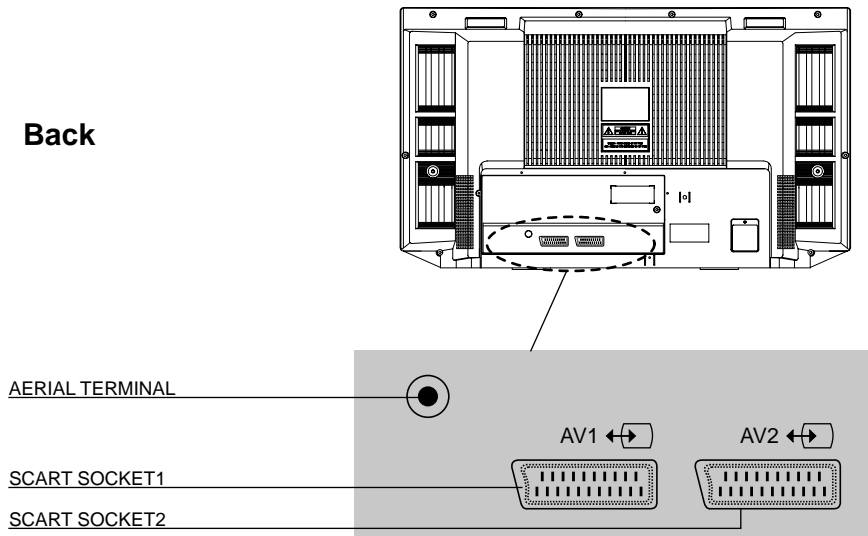



REMOTE CONTROL UNIT

TV mode

- 1 POWER
- 2 NUMBER 0-9
- 3 NORMAL / OK
- 4 TV / AV
- 5 PR UP (CURSOR UP)
- 6 VOLUME UP (CURSOR RIGHT)
- 7 MENU
- 8 PR DOWN (CURSOR DOWN)
- 9 VOLUME DOWN (CURSOR LEFT)
- 10 MUTE
- 11 RECALL
- 12 SLEEP
- 13 not used
- 14 MOVE (Edit mode only)
/⏪(Smart Sound Change)
- 15 SKIP (Edit mode only)
- 16 TV / TEXT
- 17 DELETE (Edit mode only)/ZOOM
- 18 MODE (Sound Mode Change)

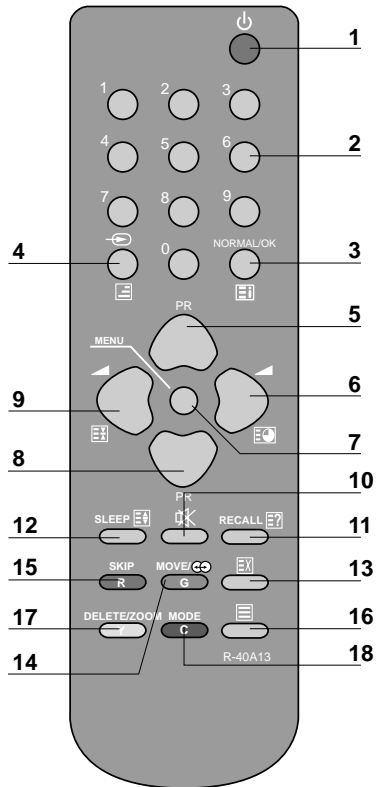

TELETEXT mode

- 1 POWER
- 2 NUMBER 0-9
- 3 INDEX
- 4 MIX
- 5 PAGE UP
- 6 SUBPAGE
- 7 MENU
- 8 PAGE DOWN
- 9 HOLD
- 10 MUTE
- 11 REVEAL
- 12 SIZE
- 13 CANCEL
- 14 GREEN KEY
- 15 RED KEY
- 16 TEXT / TV
- 17 YELLOW KEY
- 18 CYAN KEY

CONNECTING THE EXTERNAL EQUIPMENT

TV and AV

Use the TV / AV button (—⊖) on the remote control unit or on the front of the set to select one of the three options. Whenever the TV / AV button (—⊖) is pressed, the on-screen display will be changed as shown: AV1 ► AV2 ► S-VHS ► TV

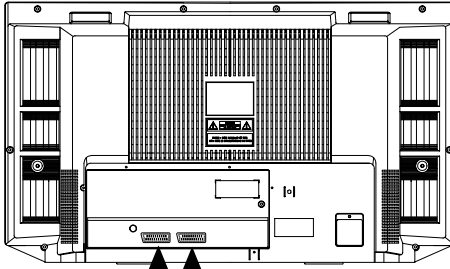

SCART JACK 1 (AV1) :

This is used to connect a VCR, a PERI-TV decoder, a Camcorder or a video game console . In most cases, the set changes automatically to AV when the VCR connected is in display mode . If not, press the TV AV button (—⊖) on the remote control unit or on the front of the set . You must turn the external equipment off or press the TV / AV button to return to the TV mode .

SCART JACK 2 (AV2) :

This is used to connect a VCR, a Camcorder or a S-VHS VCR . You can also receive the S-VHS signal with SCART JACK2 by selecting S-VHS mode with AV button (—⊖) .

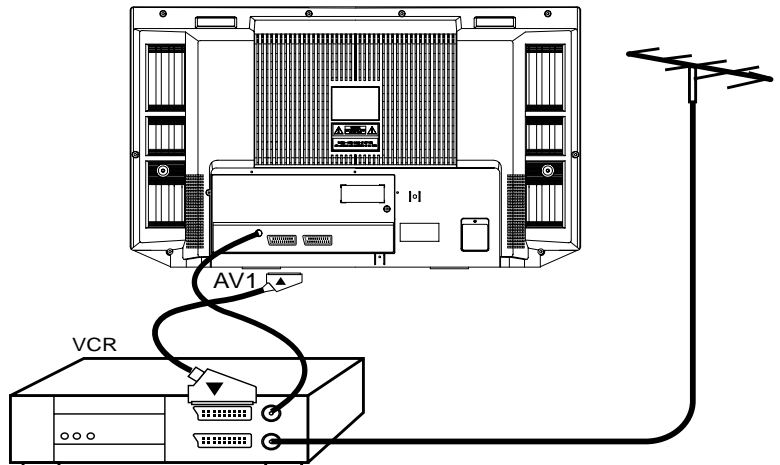

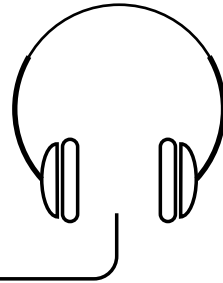
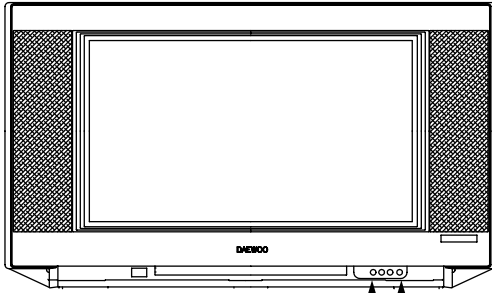

HEADPHONE JACK

Insert the headphone plug (3,5 mm)
into the headphone socket.
The sound from the speaker will be cut off.

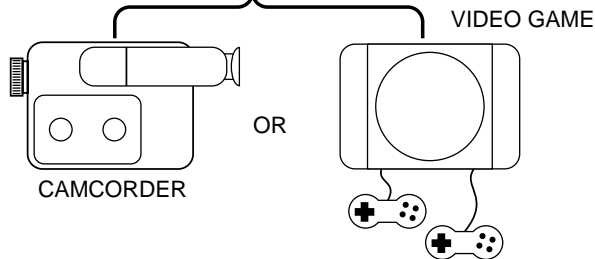

FRONT AV JACK

Connect the AV (Audio/Video) socket with an appropriate
cable to the corresponding socket of the external equipment .
Select AV mode by pressing the TV / AV button.
Press the TV / AV button to return to the TV mode .

NOTE : If two pieces of equipment are connected, one to the front AV JACK and
a second to the SCART JACK 2, you can play only one apparatus, the
second one must be switched off.

DAILY USE

PROGRAMME SELECTION

① Direct selection

Use remote control NUMBER buttons. For two digit programme numbers, press the button for the second digit within 2.5 seconds.

② Up/Down moves

Use PR UP/DOWN buttons on the remote control unit or on the front of the set.

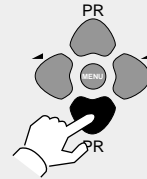

SOUND CONTROL

③ Mono forcing

If you are unable to get good sound on a channel due to a poor stereo broadcasting signal, you can change from stereo to mono transmission by pressing the remote control MODE button. Then the programme status concerning this programme indicates "Mono" (in red colour)

For other adjustments (bass, treble, balance and sound effect) see sound menu page ⑫ .

PICTURE CONTROL

You can choose between three picture settings, using repeatedly the remote control NORMAL button :

- Normal I (standard hard picture)
- Normal II (standard soft picture)
- Favourite (you can adjust picture setting to your own Preference, using the Picture menu)

For other adjustments : Brightness, contrast, colour, sharpness, see Picture menu. (page ⑪)

SLEEP FUNCTION

The sleep function will switch the television to stand-by after a set period of time.

Pressing the remote control SLEEP button repeatedly, you can enter one of the following settings :
OFF >30 min > 60 min >
90 min >120 min >OFF

ASPECT MENU

Whenever the "ZOOM" button is pressed, the screen will be changed as shown;

Auto->16:9->Zoom->Panorama->Auto...



SOUND CONTROL

①

Volume adjustment

Use VOLUME UP/DOWN buttons on the remote control unit or on the front of the set.

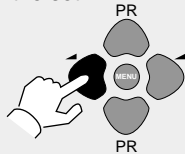

②

Mute

Turn the sound off by pressing the remote control MUTE () button.

Then the logo () is displayed on the screen. Sound returns by pressing the same button once more.

The remaining time before TV turn-off is displayed on programme status.

PROGRAMME STATUS DISPLAY

Programme number

Channel name

01 BBC 1

Clock

NICAM STEREO
11:11

Sound transmission mode :
Displayed in red color
only if forced to mono
by MODE button

SLEEP 60

Remaining time (minutes)
before Tv set turns off.

Only when sleep function is activated

Note that.

Language selection, Child lock, Clock setting and wake time setting are available in features menu. (see page 13 , 14)

MENUS

All menus are removed within 25 seconds if you don't press any button.

MAIN MENU

①

Direct selection

- Press remote control MENU button to display main menu.
- Then, you have the choice between several sub-menus .

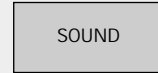
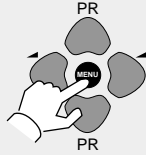

HOW TO USE SUB MENUS

①

- Select the function you want to change using remote control CURSORS UP or DOWN buttons.

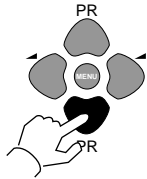

②

- Adjust the function using : Remote control CURSORS LEFT or RIGHT button.

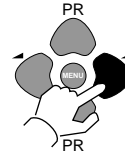

PICTURE MENU

- Press the OK button to enter the appropriate sub menu.



- Select and adjust the level of each function : "bright", "contrast", "colour" and "sharpness".
- Selected values are automatically stored in favourite mode.

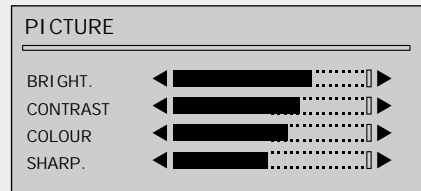



②

If you want to cancel immediately the main menu, press MENU button once more.

- To select one of the sub-menus, use remote control CURSORS buttons UP, DOWN, LEFT, RIGHT.
- To enter the selected sub-menu, press remote control OK button .

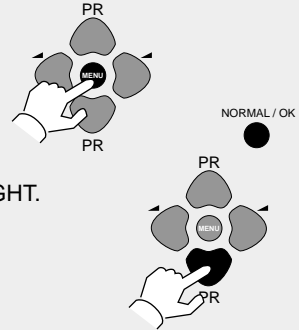

③

- Confirm (if needed) by pressing remote control OK button .

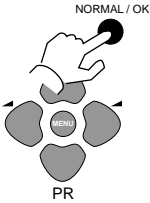

④

- Then Return to main menu pressing MENU button .

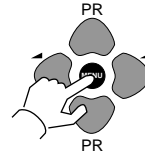

SOUND MENU

- Select and adjust the level of each function :

"VOLUME",
"BASS",
"TREBLE",
"BALANCE"
and "EFFECT"

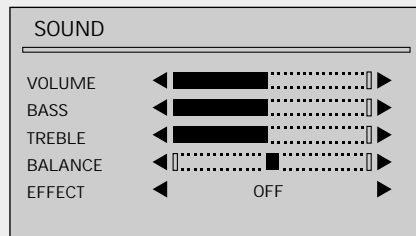

* You can change the "EFFECT" as the following:

1. Available only for Dolby Virtual models.
OFF -> SPATIAL -> PANORAMA -> DOLBY VIRTUAL -> OFF...
2. Available only for Non-Dolby Virtual models.
OFF -> SPATIAL -> OFF...

MENUS

FEATURES MENU

1. Language selection

2. Child lock prevents the use of the TV set without remote control unit.

3. TV clock setting

- Note that if you turn off the set with the MAIN POWER button, the clock setting is lost and must be reset if necessary. The clock is set automatically if programme NO. 1 is selected for at least 6 seconds, and programme NO. 1 has teletext data.

4. Wake up function

The TV set turns on at the time and with the programme chosen by the customer. This function is only available when clock is set and when TV set is switched to stand -by mode.

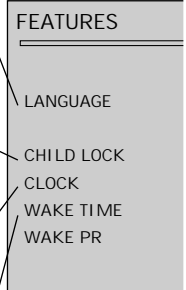

INSTALL MENU

Automatic Tuning and Sorting system

Programme list edition

TV system selection

Channel number

Channel Frequency

Channel name

Programme number

Programme storage number

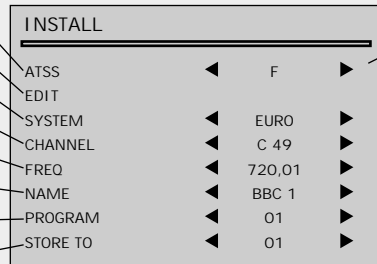

Country



1. Select the menu language.

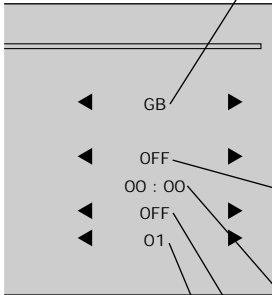

2. Child lock Select this value ON or OFF:

- When switched ON: the stand-by indicator will flash red and green, child lock is operating.
- The set can only be switched ON with the remote control unit.

3. Set TV clock with remote control 0 9 NUMBER buttons, then clock starts.

4. Switch "wake up" function ON/OFF with

- remote control CURSOR LEFT or RIGHT button
- Enter wake up time with remote control 0...9 NUMBER buttons NB. This function doesn't work with CHILD LOCK ON.

5. Select TV programme number that will appear when set comes on.

EDIT MENU

Programme number

Station name

Channel number

EDIT			
PR	NAME	CH	SKIP
05	CH 5	C21	
04	CH 4	C29	
03	ITV	C32	
02	BBC 2	C48	
01	BBC 1	C69	
99	----	C10	✓
98	----	C04	✓

These are examples and could be any number between Ch21 and Ch69.

Skip code

✓ : programme skipped.

Automatic Tuning and Sorting System

- Select "ATSS" function.
- Select required country.
- Note for satellite receiver users :
Before starting ATSS, connect your equipment to the TV set, or via the VCR, turn it ON and tune in SKY NEWS.
- Press remote control "OK" button for more than 3 seconds to start the automatic tuning.
- When automatic tuning is finished, recordable programmes are displayed on screen.

This menu shows the programme position assignment, you can change the programme position according to your personal preference.

- Select the "EDIT" function and confirm by pressing The remote control "OK" button : Edit menu appears and shows the existing programmes already tuned.
- The number a programme is already Stored/Assigned to can be altered to your personal preference as follows:

①

Channel skipping

- You can select skip "YES" or "NO" using the remote control SKIP button .
A programme with skip "✓" doesn't appear on screen when changing programmes with PR UP/ DOWN buttons.

②

Channel deleting

- Select the programme to delete using remote control CURSOR UP/ DOWN buttons.
- Press the remote control DELETE button .
The deleted programme is moved to the programme number 99 with skip "✓".
The existing 99 programme is moved to programme number 98 and so on.

③

Channel order changing

- Select the programme you wish to move using the remote control CURSOR UP(▲) / DOWN(▼) button.
- Press the remote control MOVE button : the programme appears in red and can be moved to another position using remote control CURSOR UP/ DOWN buttons.
- When the required position is reached, confirm this new position by pressing the remote control MOVE button. Then, the programme appears again on green.

④

Station name entering - copying a programme to another programme number

- Use Install menu "Name" and " Store to" functions as explained in the manual channel tuning paragraph.



①

Choose starting point

Select the "Program" function and then the programme which you want to start manual tuning. Then, the channel number, the frequency, if you don't know the frequency or channel number then refer to channel searching section. The name and the programme number of this programme are displayed in the install menu.

③

Channel searching

- Select "Freq." function.
- Press the remote control CURSOR RIGHT / LEFT buttons for more than 3 seconds to start (up / down) manual tuning.
- After searching, tuning will stop automatically to the next channel.
(To stop searching press the remote control MENU button)

Note: If you know the channel number or the frequency of the channel you want to search, you can set these channels, entering the data directly into "channel" or "Freq." setting option.

⑤

Enter station name

- Select "name" function.
- Use the CURSOR RIGHT/LEFT buttons to select the character (letter) you want to insert.
- To modify this letter press the CURSOR UP/DOWN buttons until the desired letter is displayed and press OK button to confirm.

②

TV system Selection

If necessary, you can change the TV system :

- Select "system" function.
- Choose between :
FRANCE (L/L'), GB (I),
EURO (B/G), E / EURO (D/K) system.
Then, the programme displayed on screen is changed to the system chosen.
This procedure can be applied to any individual programme selected.

④

Fine Tuning

- If you are unable to get a good picture or sound because of poor reception, it is possible to fine tune a signal.
- Select channel frequency ("Freq.") function.
- Press and release the remote control CURSOR RIGHT/LEFT buttons to fine tune a signal.

⑥

Store programmes in memory



To store a programme in memory

- Select "store to" function
- Adjust the programme number you want to store and confirm by pressing the remote control "OK" button. (Program number will briefly turn red!)

Remarks: this function can be used also if you want to copy a programme already memorised to another programme number.

TELETEXT

1- SWITCHING TELETEXT ON/OFF

- Select the channel which is broadcasting the teletext programme you want to watch
- Press the remote control TELETEXT () button to select teletext mode.
The overview station page or the last page viewed (If you watched teletext on this channel previously) appears.
- If you need to return to TV mode, press again, the remote control TELETEXT () button .

2-PAGE SELECTION



- You can enter directly the desired page number with the remote control NUMBER 0...9 buttons .
- You can sequentially select page numbers by pressing the remote control PAGE UP / DOWN buttons.
- In fast text mode, you can select directly one of the four options at the bottom of the screen using the remote control corresponding coloured buttons.

3- USEFUL FUNCTIONS WHILE WATCHING TELETEXT PAGES

INDEX () button : Allows you to return directly to the overview page of the station you are viewing.

SUBPAGE () button : Allows you to enter a subpage directly :

- Press SUBPAGE button .
- Enter directly the subpage number you want with the remote control NUMBER 0...9 buttons :
for example to enter the 2nd page, sequence 0002.
Then wait for it to appear. (Meanwhile you can watch TV by pressing the cancel button and when the page number appears press the cancel button again to retrieve this selected sub-page.)

PAGE HOLD () button : Any teletext page or subpage can be held on the screen by pressing the PAGE HOLD () button.
Press the button again to cancel the hold mode.

REVEAL () button : Press this button to reveal on certain pages, hidden information such as the answer to a quiz.
Press the button again to hide the information.



4-TELETEXT FORMAT, PICTURE, SOUND CONTROL

Doubling character size

Repeatedly pressing the SIZE () button doubles the character size in the following order :
Upper half of the page > Lower half of the page > Return to normal size.

Volume and brightness control in teletext mode

Pressing the MENU button in teletext mode, the volume and brightness control menu will be displayed at the bottom of the screen.

You can adjust volume and brightness using the corresponding colour on the remote control unit.

5-OTHER FUNCTIONS AVAILABLE

Superimpose teletext broadcasting with the current TV program using MIX button

Press MIX () button again to return to the normal teletext display.

Watch a TV programme and keep informed at the same time if some teletext pages are updated

- To do this, press CANCEL () button . Then, TV programme appears on screen and the teletext symbol appears at the top of the screen.

When teletext programme is updated, the concerned page number appears on the screen. Note that the TV programme cannot be changed with CANCEL button activated.

- Pressing the CANCEL button again, the teletext page appears with the updated information.